

COPYRIGHT © Hangzhou EZVIZ Software Co., Ltd. ALL RIGHTS RESERVED.

Any and all information, including, among others, wordings, pictures, graphs are the properties of Hangzhou EZVIZ Software Co., Ltd. (hereinafter referred to as "EZVIZ"). This user manual (hereinafter referred to as "the Manual") cannot be reproduced, changed, translated, or distributed, partially or wholly, by any means, without the prior written permission of EZVIZ. Unless otherwise stipulated, EZVIZ does not make any warranties, guarantees or representations, express or implied, regarding to the Manual.

### **About this Manual**

The Manual includes instructions for using and managing the product. Pictures, charts, images and all other information hereinafter are for description and explanation only. The information contained in the Manual is subject to change, without notice, due to firmware updates or other reasons. Please find the latest version in the EZVIZ™ website (<http://www.ezviz.com>).

### **Revision Record**

New release – January, 2021

### **Trademarks Acknowledgement**

EZVIZ™, ™, and other EZVIZ's trademarks and logos are the properties of EZVIZ in various jurisdictions. Other trademarks and logos mentioned below are the properties of their respective owners.

### **Legal Disclaimer**

TO THE MAXIMUM EXTENT PERMITTED BY APPLICABLE LAW, THE PRODUCT DESCRIBED, WITH ITS HARDWARE, SOFTWARE AND FIRMWARE, IS PROVIDED "AS IS", WITH ALL FAULTS AND ERRORS, AND EZVIZ MAKES NO WARRANTIES, EXPRESS OR IMPLIED, INCLUDING WITHOUT LIMITATION, MERCHANTABILITY, SATISFACTORY QUALITY, FITNESS FOR A PARTICULAR PURPOSE, AND NON-INFRINGEMENT OF THIRD PARTY. IN NO EVENT WILL EZVIZ, ITS DIRECTORS, OFFICERS, EMPLOYEES, OR AGENTS BE LIABLE TO YOU FOR ANY SPECIAL, CONSEQUENTIAL, INCIDENTAL, OR INDIRECT DAMAGES, INCLUDING, AMONG OTHERS, DAMAGES FOR LOSS OF BUSINESS PROFITS, BUSINESS INTERRUPTION, OR LOSS OF DATA OR DOCUMENTATION, IN CONNECTION WITH THE USE OF THIS PRODUCT, EVEN IF EZVIZ HAS BEEN ADVISED OF THE POSSIBILITY OF SUCH DAMAGES.

TO THE MAXIMUM EXTENT PERMITTED BY APPLICABLE LAW, IN NO EVENT SHALL EZVIZ'S TOTAL LIABILITY FOR ALL DAMAGES EXCEED THE ORIGINAL PURCHASE PRICE OF THE PRODUCT.

EZVIZ DOES NOT UNDERTAKE ANY LIABILITY FOR PERSONAL INJURY OR PROPERTY DAMAGE AS THE RESULT OF PRODUCT INTERRUPTION OR SERVICE TERMINATION CAUSED BY: A) IMPROPER INSTALLATION OR USAGE OTHER THAN AS REQUESTED; B) THE PROTECTION OF NATIONAL OR PUBLIC INTERESTS; C) FORCE MAJEURE; D) YOURSELF OR THE THIRD PARTY, INCLUDING WITHOUT LIMITATION, USING ANY THIRD PARTY'S PRODUCTS, SOFTWARE, APPLICATIONS, AND AMONG OTHERS.

REGARDING TO THE PRODUCT WITH INTERNET ACCESS, THE USE OF PRODUCT SHALL BE WHOLLY AT YOUR OWN RISKS. EZVIZ SHALL NOT TAKE ANY RESPONSIBILITIES FOR ABNORMAL OPERATION, PRIVACY LEAKAGE OR OTHER DAMAGES RESULTING FROM CYBER ATTACK, HACKER ATTACK, VIRUS INSPECTION, OR OTHER INTERNET SECURITY RISKS; HOWEVER, EZVIZ WILL PROVIDE TIMELY TECHNICAL SUPPORT IF REQUIRED. SURVEILLANCE LAWS AND DATA PROTECTION LAWS VARY BY JURISDICTION. PLEASE CHECK ALL RELEVANT LAWS IN YOUR JURISDICTION BEFORE USING THIS PRODUCT IN ORDER TO ENSURE THAT YOUR USE CONFORMS TO THE APPLICABLE LAW. EZVIZ SHALL NOT BE LIABLE IN THE EVENT THAT THIS PRODUCT IS USED WITH ILLEGITIMATE PURPOSES.

IN THE EVENT OF ANY CONFLICTS BETWEEN THE ABOVE AND THE APPLICABLE LAW, THE LATTER PREVAILS.

# Table of Contents

<b>Overview</b>	<b>1</b>
1. Package Contents	1
2. Basics	1
<b>Get the EZVIZ App</b>	<b>2</b>
<b>Connect to the Internet</b>	<b>2</b>
1. Option A: Wired Connection	2
2. Option B: Wireless Connection	3
<b>Installation</b>	<b>4</b>
1. Micro SD Card Installation (Optional)	4
2. Installation Location	5
3. Installation Procedure	5
<b>Operations on the EZVIZ App</b>	<b>6</b>
1. Live View	6
2. Settings	7
<b>EZVIZ Connect</b>	<b>8</b>
1. Use Amazon Alexa	8
2. Use Google Assistant	9
<b>FAQ</b>	<b>10</b>
<b>Initiatives on the Use of Video Products</b>	<b>11</b>
<b>INFORMATION FOR PRIVATE HOUSEHOLDS</b>	<b>12</b>

# Overview

## 1. Package Contents



Camera (x1)



Drilling Template (x1)



Waterproof Kit (x1)



Screw Kit (x1)



Power Adapter (x1)



Regulatory Information (x2)



Quick Start Guide (x1)

**i** The power adapter's appearance is subject to the one you have bought.

## 2. Basics

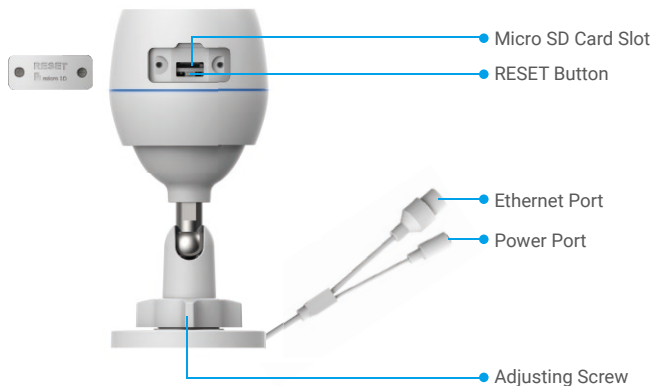

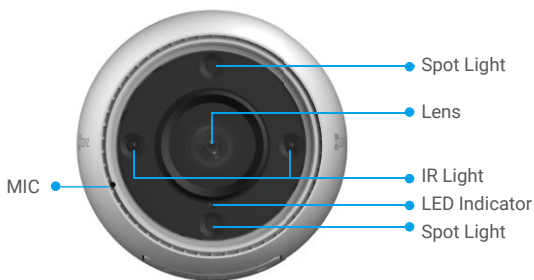

Name	Description
RESET Button	When the camera is working, press and hold for about 4s until the LED indicator is solid red, and all parameters will be restored to default settings.
LED Indicator	<ul style="list-style-type: none"> <li><span style="color: red;">■</span> Solid Red: Camera starting up.</li> <li><span style="color: red;">● ●</span> Slow-flashing Red: Network exception.</li> <li><span style="color: red;">● ● ● ●</span> Fast-flashing Red: Camera exception (e.g. Micro SD card error).</li> <li><span style="color: blue;">■</span> Solid Blue: App visiting camera.</li> <li><span style="color: blue;">● ●</span> Slow-flashing Blue: Camera running properly.</li> <li><span style="color: blue;">● ● ● ●</span> Fast-flashing Blue: Camera ready for Wi-Fi connection.</li> </ul>

## Get the EZVIZ App

1. Connect your mobile phone to Wi-Fi (suggested).
2. Download and install the EZVIZ app by searching for "EZVIZ" in the App Store or Google Play™.
3. Launch the app and register an EZVIZ user account.

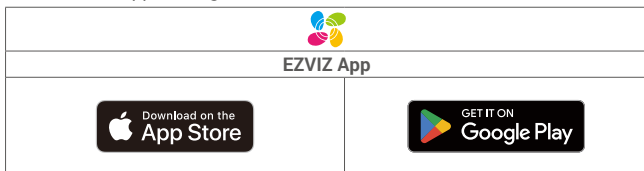

**i** If you have already used the app, please make sure that it is the latest version. To find out if an update is available, go to the app store and search for "EZVIZ".

## Connect to the Internet

- i** • Wired Connection: Connect the camera to a router. Refer to **Option A**.
- Wireless Connection: Connect the camera to Wi-Fi. Refer to **Option B**.

### 1. Option A: Wired Connection

1. Connect the power adapter cable to the camera's power port.
2. Plug the power adapter into an electrical outlet.
  - i** • Use power adapter and power cable come with the camera in the box.
  - The LED turning fast-flashing blue indicates that the camera is powered on and ready for network configuration.
3. Connect the camera to the LAN port of your router with the Ethernet cable (purchase separately).
  - i** The LED turning slow-flashing blue indicates that the camera is connected to the Internet

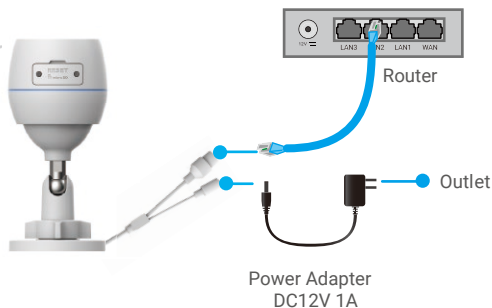

#### 4. Add your camera to EZVIZ.

- Log in to your account using the EZVIZ app.
- On the Home screen, tap "+" on the upper-right corner to go to the Scan QR Code interface.
- Scan the QR code on the Quick Start Guide cover or on the body of the camera.



- Follow the EZVIZ app wizard to add the camera to the app.

## 2. Option B: Wireless Connection

1. Connect the power adapter cable to the camera's power port.
2. Plug the power adapter into an electrical outlet.

- i** • Use power adapter and power cable come with the camera in the box.
- The LED turning fast-flashing blue indicates that the camera is powered on and ready for network configuration.

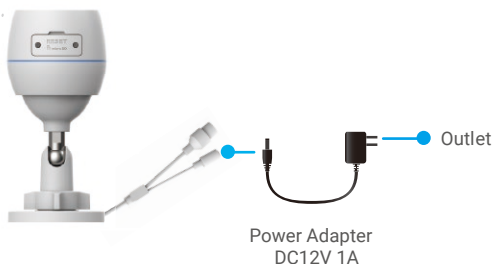

### 3. Add camera to EZVIZ.

- Log in to your account using the EZVIZ app.
- On the Home screen, tap “+” on the upper-right corner to go to the Scan QR Code interface.
- Scan the QR code on the Quick Start Guide cover or on the body of the camera.

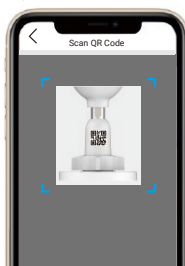

- Follow the EZVIZ app wizard to add the camera to EZVIZ.
  - i** Please choose to connect your camera to the Wi-Fi to which your mobile phone has connected.
    - The band of the Wi-Fi must be 2.4 GHz.
  - i** Press and hold the reset button for about 4s, and you can restart the camera and restore all parameters to default.  
Press and hold the reset button for about 4s in any of the following cases:
    - The camera fails to connect to your Wi-Fi network.
    - You want to connect the camera to another Wi-Fi network.

## Installation

### 1. Micro SD Card Installation (Optional)

1. Remove the cover on the camera.
2. Insert the micro SD card (sold separately) into the card slot.
3. Place the cover back on.



- i** After installing the micro SD card, you should initialize the card in the EZVIZ app before using it.
4. In the EZVIZ app, tap the Storage Status in the Device Settings interface to check the SD card status.
  5. If the memory card status displays as Uninitialized, tap to initialize it.
    - i** The status will then change to **Normal** and then videos can be stored.

## 2. Installation Location

- Choose a location with a clear, unblocked field of view and with a good wireless signal.
- Make sure that the wall is strong enough to withstand three times the weight of the camera.
- Camera cannot be installed with the lens facing direct sunlight.

## 3. Installation Procedure

1. Remove protective film from the lens.
2. Stick the drilling template onto a clean and flat surface.
3. (For cement wall only) Drill screw holes according to the template, and insert anchors.
4. Use screws to fix the camera on the installation surface.
5. Loosen the adjusting screw.
6. Rotate the upper part of the camera to get an appropriate detection effect.
7. Tighten the adjusting screw again.

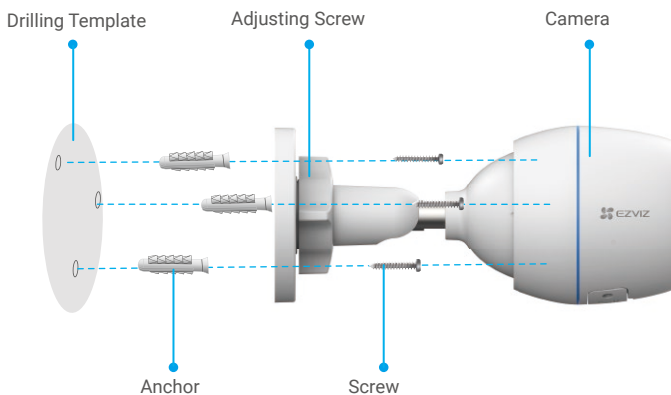

- 1 Make sure that the micro SD card slot is facing downward.









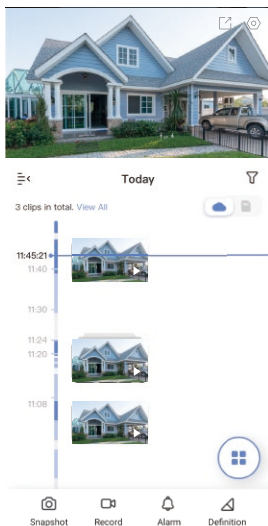

# Operations on the EZVIZ App

 The app interface may be different due to version update, and the interface of the app you installed on your phone shall prevail.

## 1. Live View

Launch the EZVIZ app, tap Live View, you can view and listen to a live feed, take snapshots, record videos, and choose video definition as needed.



Icon	Description
	Share. Share your device.
	Settings. View or change the device settings.
	Snapshot. Take a snapshot.
	Record. Manually start/stop recording.
	Alarm. Flash to deter intruders.
	Definition. Select video resolution from Ultra HD, Hi-Def or Standard.
	Multi-screen Live. Tap to select live view window layout.



## 2. Settings

Parameter	Description
Audio	If disabled, there will be no audio when you are viewing real-time videos or recorded videos
Status Light	If enabled, the LED indicator on the camera will be on; otherwise the LED indicator will not be on.
Alarm Notification	If disabled, notifications will not be pushed to your app once targets are detected. <ul style="list-style-type: none"><li>• <b>Color Night Vision:</b> Helps the camera get color images in dark environments.</li><li>• <b>Black/White Night Vision:</b> IR light helps the camera get black and white images in dark environments.</li><li>• <b>Smart Night Vision:</b> Black/White Night Vision by default. Once motion is detected, the vision mode will switch to Color Night Vision mode.</li></ul>
Time Zone	You can select time zone as needed here.
Date Format	You can select date format as needed here.
Wi-Fi	Make your device offline first, and then you can connect your device to a new network.
Cloud Storage	You can subscribe and manage the cloud storage.
Storage Status	You can see micro SD card capacity, used space and free space here.
Device Version	You can see device version here.
Image Encryption	If enabled, images captured by the camera can only be available after you enter a password.
Change Encryption Password	You can change encryption password here.
Flip Image	Tap to flip the video.
Sleep Mode	If enabled, the device will stop monitoring and recording.
Offline Notification	If enabled, notifications will be pushed to your app once the camera is offline.
User Guide	You can read user guide of the camera here.
About	You can mark where the device is installed, and get product category, device model, serial number, and device QR code here.
Restart	Tap to restart the camera.
Delete Device	Tap to delete the camera from EZVIZ Cloud.

# EZVIZ Connect

## 1. Use Amazon Alexa

These instructions will enable you to control your EZVIZ devices with Amazon Alexa. If you run into any difficulties during the process, please refer to **Troubleshooting**.

### Before you start, make sure that:

1. EZVIZ devices are connected to the EZVIZ app.
2. In the EZVIZ app, turn off the "Image Encryption" in the Device Settings page.
3. You have an Alexa-enabled device (i.e Echo Spot, Echo-Show, All-new Echo-Show, Fire TV (all generations), Fire TV stick (second generation only), or Fire TV Edition smart TVs).
4. The Amazon Alexa app is already installed on your smart device, and you have created an account.

### To Control EZVIZ devices with Amazon Alexa:

1. Open the Alexa app and select "Skills and Games" from the menu.
2. On the Skills and Games screen, search for "EZVIZ", and you will find "EZVIZ" skills.
3. Select your EZVIZ device's skill, then tap **ENABLE TO USE**.
4. Enter your EZVIZ username and password, and tap **Sign in**.
5. Tap the **Authorize** button to authorize Alexa to access your EZVIZ account, so that Alexa can control your EZVIZ devices.
6. You will see "EZVIZ has been successfully linked", then tap **DISCOVER DEVICES** to allow Alexa to discover all your EZVIZ devices.
7. Go back to Alexa app menu and select "Devices", and under devices you will see all your EZVIZ devices.

### Voice Command

Discover a new smart device via the "Smart Home" menu in the Alexa app or the Alexa Voice Control function.

Once the device is found, you can control it with your voice. Speak simple commands to Alexa.

-  Your device's name for example: "show xxxx camera," can be changed in the EZVIZ app. Each time you change the name of the device, you will need to discover the device again to update the name.

### Troubleshooting

#### What should I do if Alexa fails to discover my device?

Check if there are any Internet connecting problems.

Try to restart the smart device and re-discover the device on Alexa.

#### Why the device's status is "Offline" on Alexa?

Your device might have been disconnected from the network. Restart the smart device and re-discover on Alexa.

Check if your router is connected to the Internet and try again.

-  For details about countries where Amazon Alexa is available, see Amazon Alexa's official website.

## 2. Use Google Assistant

With the Google Assistant, you can activate your EZVIZ device and watch live by speaking Google Assistant voice commands.

### The following devices and apps are required:

1. A functional EZVIZ app.
2. In the EZVIZ app, turn off the "Image Encryption" and turn on the "Audio" in the Device Settings page.
3. A TV with functional Chromecast connecting to it.
4. The Google Assistant app on your phone.

### To get started, follow the steps below:

1. Set up the EZVIZ device and make sure it works properly on the app.
2. Download the Google Home app from the App Store or Google Play Store™ and log into your Google account.
3. On the Myhome screen, tap "+" on the upper-left corner, and select "Set up device" from the menu list to go to the Set up interface.
4. Tap **Works with Google**, and search for "EZVIZ", where you will find "EZVIZ" skills.
5. Enter your EZVIZ username and password, and tap **Sign in**.
6. Tap the **Authorize** button to authorize Google to access your EZVIZ account, so that Google can control your EZVIZ devices.
7. Tap **Return to app**.
8. Follow the above steps to complete the authorization. When synchronization is completed, EZVIZ service will be listed under your list of services. To see a list of compatible devices under your EZVIZ account, tap on the EZVIZ service icon.
9. Now try some commands. Use the name of the camera that you created when you set up the system.

Users can manage devices as a single entity or in a group. Adding devices to a room allows users to control a group of devices at the same time using one command.

See the link for more information:

<https://support.google.com/googlehome/answer/7029485?co=GENIE.Platform%3DAndroid&hl=en>

 For additional information about the device, please refer to [www.ezviz.com/eu](http://www.ezviz.com/eu).

## FAQ

**Q: If the camera is offline on the App, will the video recording continue?**

A: If the camera is powered on but disconnected from the Internet, then local recording will continue but cloud recording will stop. If the camera is powered off, both video recordings will stop.

**Q: Why the alarm is triggered when nobody in the image?**

A: Configure a lower value for the detection sensitivity. Please notice that vehicle and animals are also alarm triggering sources.

**Q: How to use the micro SD card for local storage?**

A: 1. Make sure that there is a micro SD card inserted and the camera is added to your EZVIZ account. Open the EZVIZ app and enter the "Device Details" interface, if the "Initialize Storage Card" button appears, you need to initialize the micro SD card first.

2. The micro SD card recording for the motion detection is enabled by default.

**Q: The mobile phone cannot receive alarm prompts when the camera is online.**

A: 1. Make sure that the EZVIZ app is running on your mobile phone and that the Motion Detection Notification is enabled.

2. For Android system, make sure that the app is running in background; and for iOS, enable the message push function in "Settings > Notification".

3. If still no alarm prompts, press and hold the RESET button for about 4 seconds to restore the camera settings.

**Q: Live view or playback failed.**

A: Make sure that your network is well connected. Watching live videos needs a good bandwidth. You can refresh the video, or change a network and try again.

## Initiatives on the Use of Video Products

Thank you for choosing EZVIZ products.

Technology affects every aspect of our life. As a high-tech company, we are increasingly aware of the role technology plays in improving business efficiency and quality of life, but at the same time, the potential harm of its improper usage. For example, video products are capable of recording real, complete and clear images. This provides a high value in retrospect and preserving real-time facts. However, it may also result in the infringement of a third party's legitimate rights and interests if improper distribution, use and/or processing of video data takes place. With the philosophy of "Technology for the Good", EZVIZ requests that every end user of video technology and video products shall comply with all the applicable laws and regulations, as well as ethical customs, aiming to jointly create a better community.

Please read the following initiatives carefully:

1. Everyone has a reasonable expectation of privacy, and the installation of video products should not be in conflict with this reasonable expectation. Therefore, a warning notice shall be given in a reasonable and effective manner and clarify the monitoring range, when installing video products in public areas. For non-public areas, a third party's rights and interests shall be evaluated when installing video products, including but not limited to, installing video products only after obtaining the consent of the stakeholders, and not installing highly-invisible video products.

2. The purpose of video products is to record real activities within a specific time and space and under specific conditions. Therefore, every user shall first reasonably define his/her own rights in such specific scope, in order to avoid infringing on a third party's portraits, privacy or other legitimate rights.

3. During the use of video products, video image data derived from real scenes will continue to be generated, including a large amount of biological data (such as facial images), and the data could be further applied or reprocessed. Video products themselves could not distinguish good from bad regarding how to use the data based solely on the images captured by the video products. The result of data usage depends on the method and purpose of use of the data controllers. Therefore, data controllers shall not only comply with all the applicable laws and regulations and other normative requirements, but also respect international norms, social morality, good morals, common practices and other non-mandatory requirements, and respect individual privacy, portrait and other rights and interests.

4. The rights, values and other demands of various stakeholders should always be considered when processing video data that is continuously generated by video products. In this regard, product security and data security are extremely crucial. Therefore, every end user and data controller, shall undertake all reasonable and necessary measures to ensure data security and avoid data leakage, improper disclosure and improper use, including but not limited to, setting up access control, selecting a suitable network environment (the Internet or Intranet) where video products are connected, establishing and constantly optimizing network security.

5. Video products have made great contributions to the improvement of social security around the world, and we believe that these products will also play an active role in more aspects of social life. Any abuse of video products in violation of human rights or leading to criminal activities are contrary to the original intent of technological innovation and product development. Therefore, each user shall establish an evaluation and tracking mechanism of their product application to ensure that every product is used in a proper and reasonable manner and with good faith.

## INFORMATION FOR PRIVATE HOUSEHOLDS

1. Separate collection of waste equipment: Electrical and electronic equipment that has become waste is referred to as waste equipment. Owners of waste equipment must dispose of it separately from unsorted municipal waste. In particular, waste equipment does not belong in household waste, but in special collection and return systems.

2. Batteries and rechargeable batteries as well as lamps: Owners of waste equipment shall, as a rule, separate waste batteries and rechargeable batteries that are not enclosed in the waste equipment, which can be removed from the waste equipment without being destroyed, from the waste equipment before handing them in at a collection point. This does not apply if waste equipment is prepared for reuse with the participation of a public waste management authority.

3. Options for returning waste equipment: Owners of waste equipment from private households can return it free of charge to the collection points of the public waste management authorities or to the take-back points set up by manufacturers or distributors within the meaning of the Electrical and Electronics Equipment Law. Stores with a sales area of at least 400 m<sup>2</sup> for electrical and electronic equipment and those grocery stores with a total sales area of at least 800 m<sup>2</sup> that offer electrical and electronic equipment several times a year or on a permanent basis and make it available in the market are required to take it back. This also applies in the case of distribution using means of distance communication, if the storage and shipping areas for electrical and electronic equipment are at least 400 m<sup>2</sup> or the total storage and shipping areas are at least 800 m<sup>2</sup>. Distributors shall, in principle, ensure take-back by providing suitable return facilities at a reasonable distance from the respective end user. The possibility of returning waste equipment free of charge exists for distributors who are obliged to take it back, among other things, if a new similar device that essentially fulfills the same functions is delivered to an end user.

4. Privacy Notice: Waste equipment often contains sensitive personal data. This applies in particular to devices of information and telecommunications technology such as computers and smartphones. In your own interest, please note that each end user is responsible for deleting the data on the waste equipment to be disposed of.

5. Meaning of the symbol “crossed-out wheelee bin”: The symbol of a crossed-out wheelee bin regularly depicted on electrical and electronic equipment indicates that the respective device is to be collected separately from unsorted municipal waste at the end of its service life.