



# SECURITY

## Series 4R & 4L

Security electric strikes are designed for doors connected to fire and **access control systems** or doors requiring a high level of security.

The zamak housing has been reinforced, in order to ensure higher resistance. The keeper is anchored through four support points.

DC models are equipped with electronic protection in order to prevent damages to your access control system. This also represents an advantage for the installer as the connection is not polarized.

They are manufactured for both right and left opening doors featuring a wide variety of functions and voltages, these strikes quickly unlock standard doors through low power consumption.

### Technical features

- Guaranteed endurance rating: 300.000 cycles (120N side-load on AC)  
Max. side-load on AC: 160 N  
Max. side-load on DC: 10 N
- Break-in resistance: 7.000 N
- Dynamic Strength: 33 ft lbf
- Operating temperature range: -15 °C /+40 °C
- Housing Material: Reinforced Zamak
- Keeper Material: Steel  
Keeper Depth: 9,48 mm
- Guaranteed 3 years.
- Complies with 2004/108/CE (EN 55014)
- Corrosion resistant according to UNI ISO 9227

### Coil features

- |   |                                    |
|---|------------------------------------|
| <b>L</b> 8-14 V ac/dc < 1min<br>(20 Ω 0,48A at 12 V ac) | <b>M</b> 12 V dc ∞<br>(70 Ω 0,17A) |
| <b>N</b> 24 V dc ∞<br>(240 Ω 0,10A)                     | <b>P</b> 12 V dc ∞<br>(54 Ω 0,22A) |

### Special coils available upon request:

- D** 24 V ac/dc < 1min

## References and features

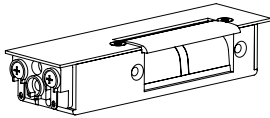
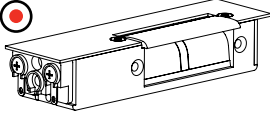
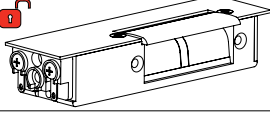
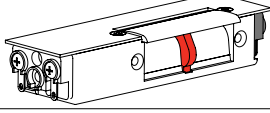
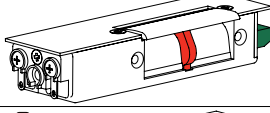
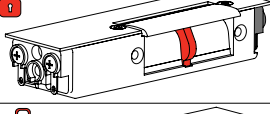
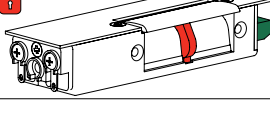
	Fixed keeper	Side-load	Electronic protection	Voltage	References DIN right add faceplate	References DIN left add faceplate
 <b>Fail-secure</b>	●	●		8-14 V ac/dc	<b>4R0.4.00.L</b>	<b>4L0.4.00.L</b>
	●		●	12 V dc	<b>4R0.4.00.M</b>	<b>4L0.4.00.M</b>
	●		●	24 V dc	<b>4R0.4.00.N</b>	<b>4L0.4.00.N</b>
 <b>Internal Hold-open</b>	●	●		9-14 V ac/dc	<b>4R2A.4.00.L</b>	<b>4L2A.4.00.L</b>
 <b>Fail-safe</b>	●		●	12 V dc	<b>4R4.4.00.M</b>	<b>4L4.4.00.M</b>
	●		●	24 V dc	<b>4R4.4.00.N</b>	<b>4L4.4.00.N</b>
 <b>Fail-secure with monitoring</b>	●	●		8-14 V ac/dc	<b>4R6.4.00.L</b>	<b>4L6.4.00.L</b>
	●		●	12 V dc	<b>4R6.4.00.M</b>	<b>4L6.4.00.M</b>
	●		●	24 V dc	<b>4R6.4.00.N</b>	<b>4L6.4.00.N</b>
 <b>Fail-secure with double monitoring</b>	●		●	12 V dc		<b>47.4.00.P</b>
	●		●	24 V dc		<b>47.4.00.N</b>
 <b>Fail-safe with monitoring</b>	●		●	12 V dc	<b>4R8.4.00.M</b>	<b>4L8.4.00.M</b>
	●		●	24 V dc	<b>4R8.4.00.N</b>	<b>4L8.4.00.N</b>
 <b>Fail-safe with double monitoring</b>	●		●	12 V dc		<b>49.4.00.P</b>
	●		●	24 V dc		<b>49.4.00.N</b>

## Monitoring features

	Intensity	Contact resistance	Insulation resistance	Operating temperature
<b>Microswitch S1</b>	1A/125V ac 0,5A/30V dc	50 mΩ maximum	100 MΩ minimum [at 500V dc]	From -25°C to 65°C (without ice)
<b>Microswitch S2</b> <b>IP40</b>	0,5A/30V dc	30 mΩ maximum	100 MΩ minimum [at 500V dc]	From -25°C to 70°C (without ice)

## Recommended Faceplates

### SHORT

61 SST  
66 SST

### LONG

43 SST  
67 SST  
71 SST

### ANGLED

16 Brown  
17 Brown  
45 Brown  
48 Brown  
49 SST  
50 SST

## Dimensions

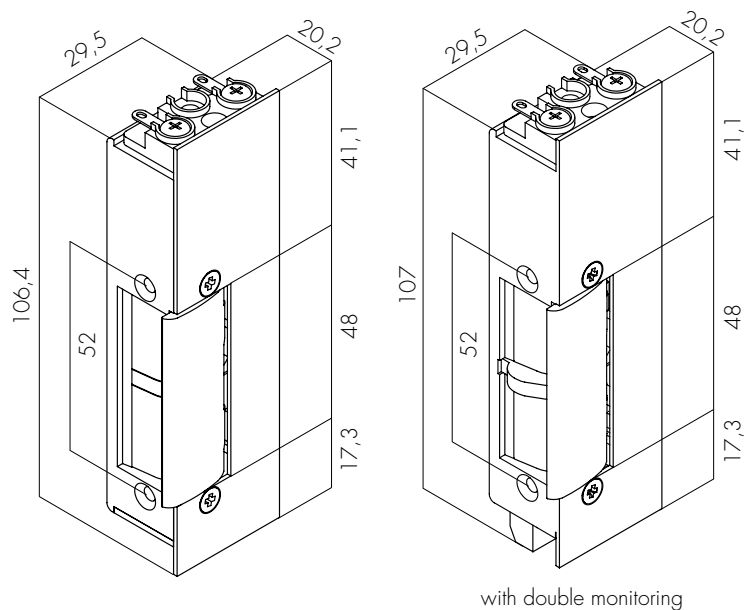

with double monitoring